

ARCHITECTURAL HARDWARE

Door furniture

*Securing people and assets with
seamless access wherever they
reside, work and thrive.*

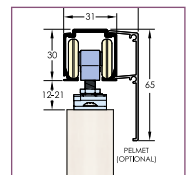

ALLEGION™

Quality starts with performance and durability

The first point of contact for anyone entering and moving around a building is the door hardware, whether that is a pull handle or a lever handle. In addition to having the right look, the hardware you select must have the right feel and finish and be backed up by a level of performance which will ensure the hardware is suited to the application and the amount of use it will have to endure.

Specifying Allegion furniture

The ranges of door furniture available from Allegion enable specifiers to select items across the full hardware requirement of the door and beyond from the same range. This ensures full compatibility of the fittings, producing a unified appearance in all cases.

Whether your choice is for satin stainless steel or solid nylon, all the components within the range are produced to a high standard of

finish and with a level of certified performance suitable for the majority of applications.

Briton, Randi and Normbau lever furniture is fully compatible across the entire range of Briton and CISA lockcases. However, only specific lever handles are certified for use on escape route doors which have been fitted with escape sashlocks. These are identified in the following pages but we recommend you

consult our Technical Department for further information.

Performance Levels

Our multi-level approach to door furniture ensures there is a solution for all projects, applications and budgets.



EN 1906

All forms of lever and knob door operating furnitures are covered by EN 1906. It provides details on product types by use, durability testing, fire resistance, corrosion resistance and safety using an 8 digit classification code.

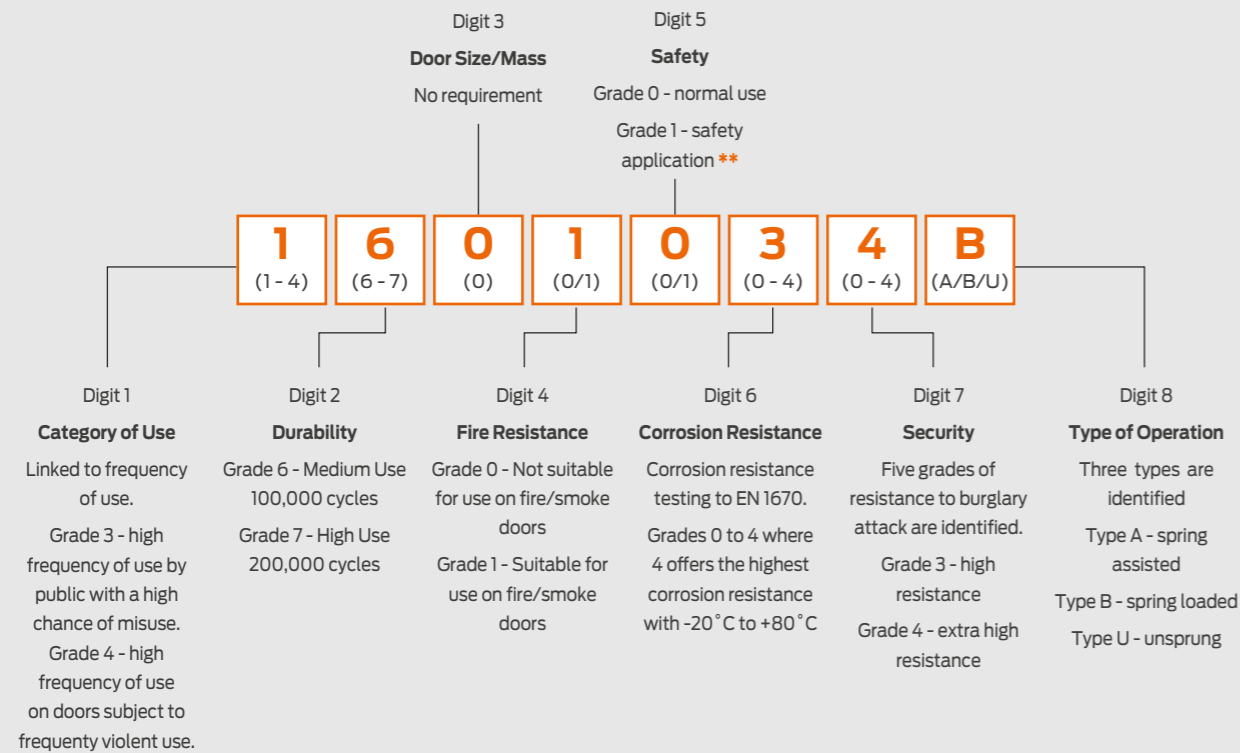

** to qualify for Grade 1 Safety, handles must have high strength lever to plate/rose fixing, high strength plate/rose to door fixing and high strength lever to spindle fixing, such that they would withstand a person grabbing the lever in order to prevent falling.

It is recommended that only Safety Grade 1 furniture is used on doors at the top of a staircase for example.

EN 1935

Single axis hinges, both fixed pin and lift off hinges, are covered by EN 1935. It provides details on product types by use, durability, fire resistance, corrosion resistance and a grading using an 8 digit classification code.

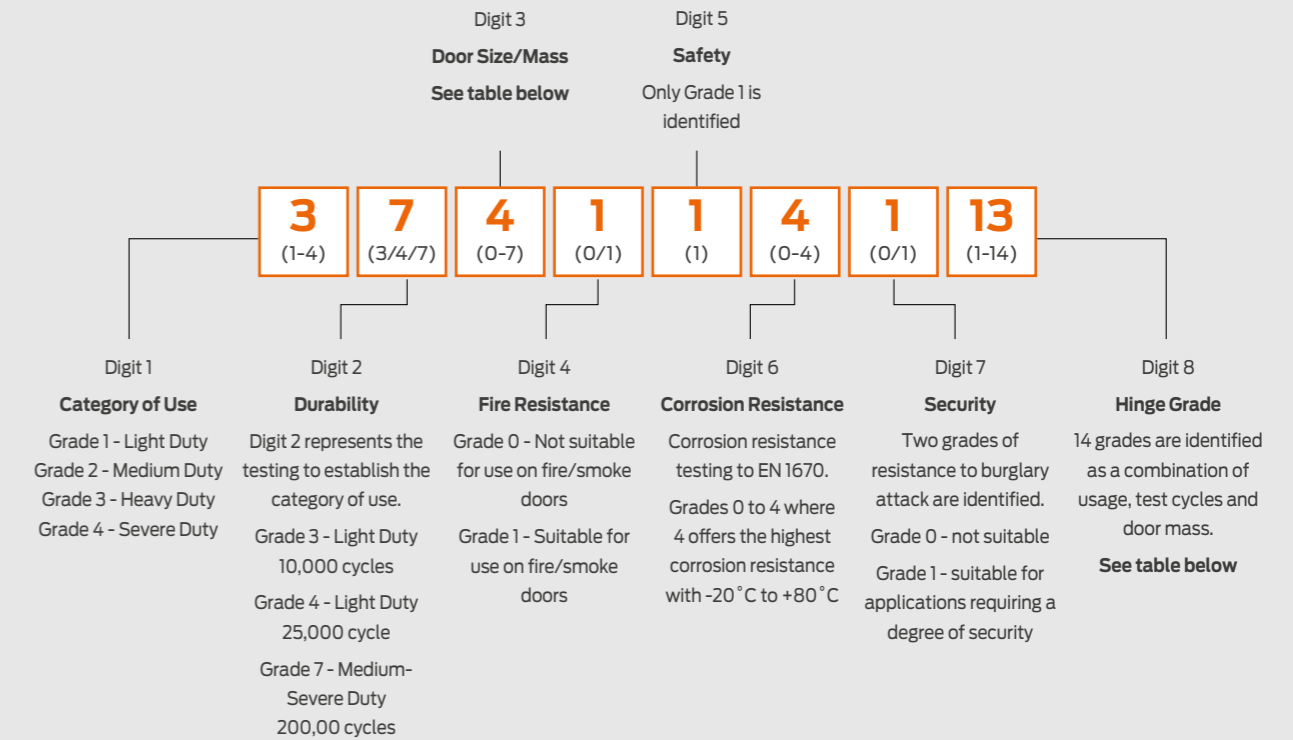

Door Size/Mass

Grade	Door Mass
0	10kg
1	20kg
2	40kg
3	60kg
4	80kg
5	100kg
6	120kg
7	160kg

Hinge Grades

Grade	Usage	Test Cycles	Door Mass
1	Window	10,000	10kg
2	Window	10,000	20kg
3	Window/Door	25,000	20kg
4	Door	200,000	20kg
5	Window	10,000	40kg
6	Window/Door	25,000	40kg
7	Door	200,000	40kg
8	Window	10,000	60kg
9	Window/Door	25,000	60kg
10	Door	10,000	60kg
11	Door	200,000	80kg
12	Door	200,000	100kg
13	Door	200,000	120kg
14	Door	200,000	160kg

The Equality Act - disability legislation

The concept of universal access is not new but it still provides a challenge for the construction industry.

Legislation aimed at providing universal accessibility of buildings requires service providers to make "reasonable adjustments to the physical features of their premises to overcome barriers to access".

To meet obligations under the Equality Act, Approved Document M (ADM) of The Building Regulations and BS 8300 continue to be the yardsticks by which conformity is measured.

Products in this category which conform to the recommendations of BS 8300 and ADM are shown with this symbol.



BS 8300 - Dimensional guidance

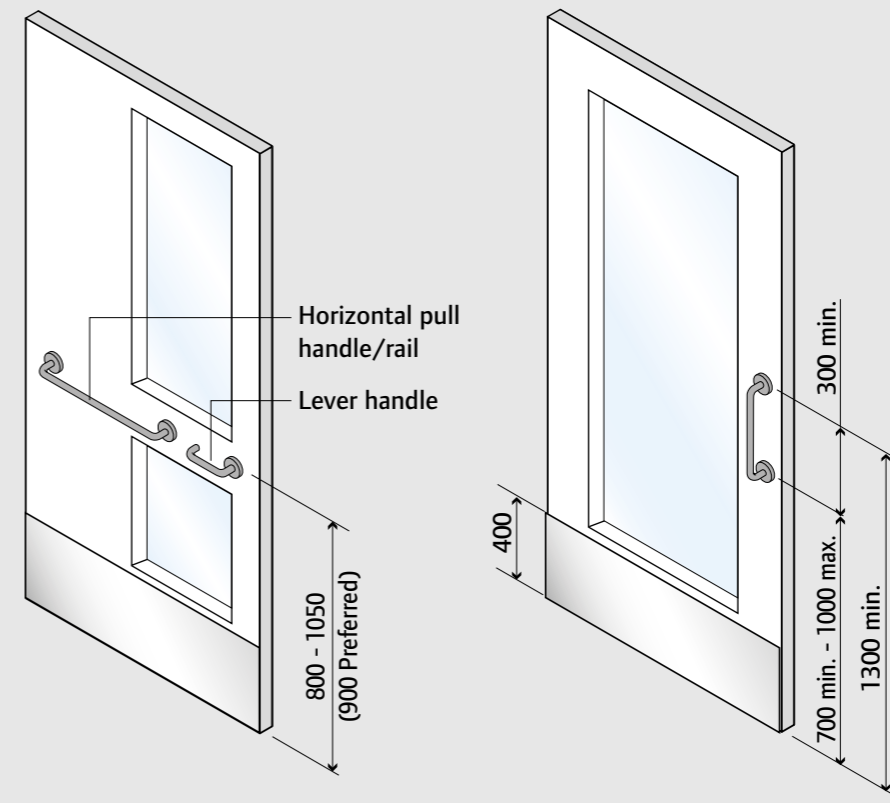

BS 8300 & ADM

Approved Document M of The Building Regulations stipulates that operating hardware "... can be operated with one hand using a closed fist, e.g. a lever handle."

BS 8300 however is more specific and sets out both dimensional recommendations and mounting positions which are shown opposite.

To assist people with a visual impairment, BS 8300 also includes a recommendation for visual contrast between the door and

its operating hardware measured as the difference in their light reflective value (LRV). Whilst there is no definitive answer, research has shown that a minimum of 30 points of difference in LRV is recommended although 20 points may also be considered to be acceptable.

Allegion can provide LRV measurements where necessary.

Lever handle dimensions

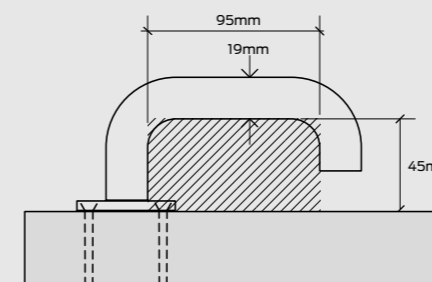

Pull handle dimensions

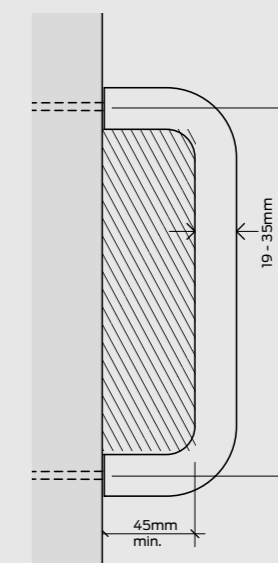

4700 Series - Door Furniture

The 4700 Series furniture range offers specifiers a wide choice of styles for lever and pull handles, which are ideally matched with Briton high performance lockcases, and Briton and CISA Euro profile cylinders for optimum performance.

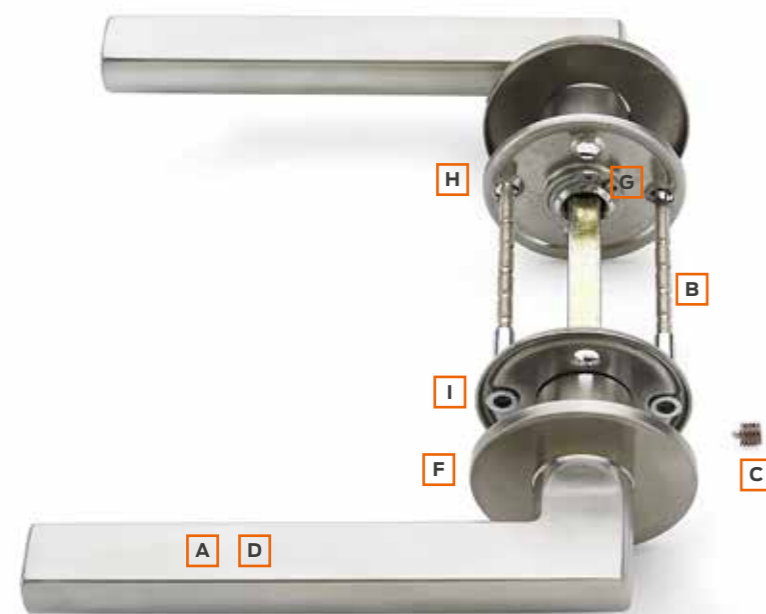

Grade 4 category of use guarantees a high performance and durability

Features & Benefits

- A Precision manufactured levers in stainless steel Grade 304
- B Back to back fixing bolts and threaded bushes on lever furniture provide a strong bolt through fixing. Supplied as standard to suit doors 44 - 54mm thick (alternative fixing pack available to suit 55 - 65mm)
- C Spindle is fixed to the inside and the outside lever handle by "break thru" grub screws providing greater security and durability.
- D All lever handles achieve EN 1906 Grade 4, the highest grade of use within the standard*.
- E Grub screw fixings on levers concealed from view on the underside.
- F Slimline roses only 4mm thick.
- G Precision engineered levers are prefixed to the rose or plate inner by hi-tensile circlip.
- H Unique 'ClickFit' system provides a positive snap fit for pressed rose and escutcheon covers.
- I Torx head fixings supplied with all leversets and plate mounted levers provide a high quality look and minimise tampering.

Lever fixing

Lever furniture features a unique fixing method which provides a firm, positive and highly durable installation. Levers are prefixed to roses, roses are fixed with bolt through fixings and break thru through fixings and break thru spindle and grub screws which positively connect the inside and outside handles.

Testing & Certification

Tested to EN 1906 with Grade 4 Category of Use

Tested to EN 1673 with Grade 3 Corrosion Resistance

Fire tested to EN1634 on timber doors to achieve a 90 minute fire rating, and 4 hour for metal doors.

Full Declaration of Performance available from our website at:

www.britondops.co.uk



What's in the box?

- Pair of levers on roses
- Push on rose covers
- 8mm spindle & bolt through fixings for 35 - 54mm doors
- Hexagon wrench
- Installation instructions



4700 Series - Lever Furniture

The full hardware requirement from a single source



Return to Door - 4701.20.140

Ø20mm round bar lever handle on rose with bolt through fixings at 38mm centres.

Approved for use with escape locks to EN 179.

Conforms to dimensional recommendations of BS 8300.

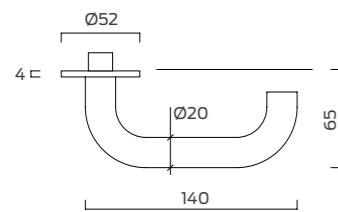

Return to Door - 4701.22.140

Ø22mm round bar lever handle on rose with bolt through fixings at 38mm centres.

Approved for use with escape locks to EN 179.

Conforms to dimensional recommendations of BS 8300.

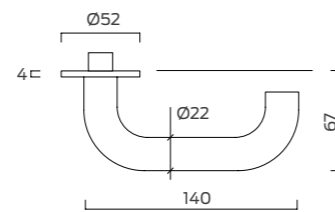

Straight - 4703.20.140

Ø20mm round bar lever handle on rose with bolt through fixings at 38mm centres.

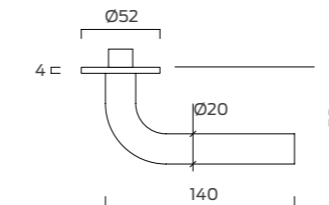

Straight Mitred - 4704

Ø20mm round bar lever handle on rose with bolt through fixings at 38mm centres.

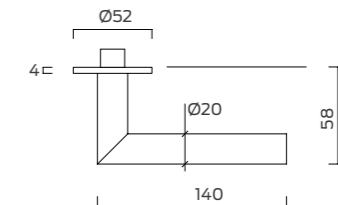

all dimensions are in mm



Extended Return to Door - 4701.20.175

Ø20mm round bar lever handle on rose with bolt through fixings at 38mm centres.

Approved for use with escape locks to EN 179.

Conforms to dimensional recommendations of BS 8300.

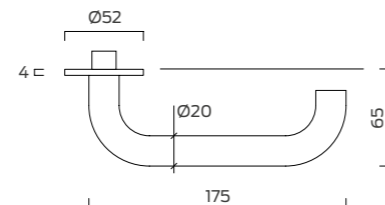

Curved Mitred - 4705.20.140

Ø20mm round bar lever handle on rose with bolt through fixings at 38mm centres.

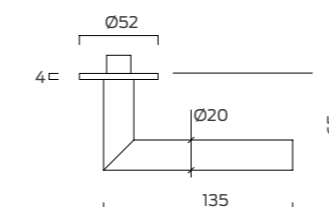

Wing Design - 4706

Formed lever handle on rose with bolt through fixings at 38mm centres.

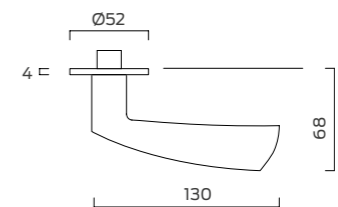

4700 Series - Lever Furniture



Hollow Cut Away - 4707

Lever handle on rose with bolt through fixings at 38mm centres.

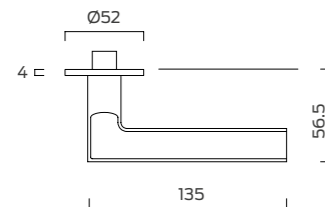

Hollow Curve - 4708

Lever handle on rose with bolt through fixings at 38mm centres.

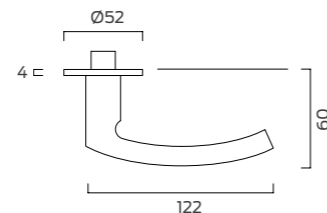

all dimensions are in mm



Product Ref:	Description	Finish
4701.20.140	Return to door lever on rose - Ø20mm	SS
4701.22.140	Return to door lever on rose - Ø22mm	SS
4701.20.175	Extended return to door lever on rose - Ø20mm	SS
4703.20.140	Straight lever on rose - Ø20mm	SS
4704	Straight mitred lever on rose - Ø20mm	SS
4705.20.140	Curved mitred lever on rose - Ø20mm	SS
4706	Wing design lever on rose	SS
4707	Hollow cut away lever on rose	SS
4708	Hollow curved lever on rose	SS
4701.55-65.FS	Alternative fixing pack for doors 55 - 65mm	n/a

Accessories to suit all mortice lock applications



Product Ref:	4702BP.B.22.140	4702BP.EC.22.140	4702BP.WC
Description:	Plate mounted Ø22mm lever handle Blank plate for use with latches	Plate mounted Ø22mm lever handle Backplate with cutout for euro profile cylinders for use with sashlocks	Plate mounted lever handle Ø22 Backplate with bathroom function turn with outside indicator and emergency release. Handed assembly - see below.
Dimensions:	170 x 170 x 2mm	170 x 170 x 2mm	170 x 170 x 2mm
Fixings:	Supplied as a pair with bolt through fixings and 8mm spindle suitable for doors 44 - 54mm *	Supplied as a pair with bolt through fixings and 8mm spindle suitable for doors 44 - 54mm *	Supplied as a pair with bolt through fixings and 8mm spindle suitable for doors 44 - 54mm*
Finish:	All items are available in Satin Stainless Steel		

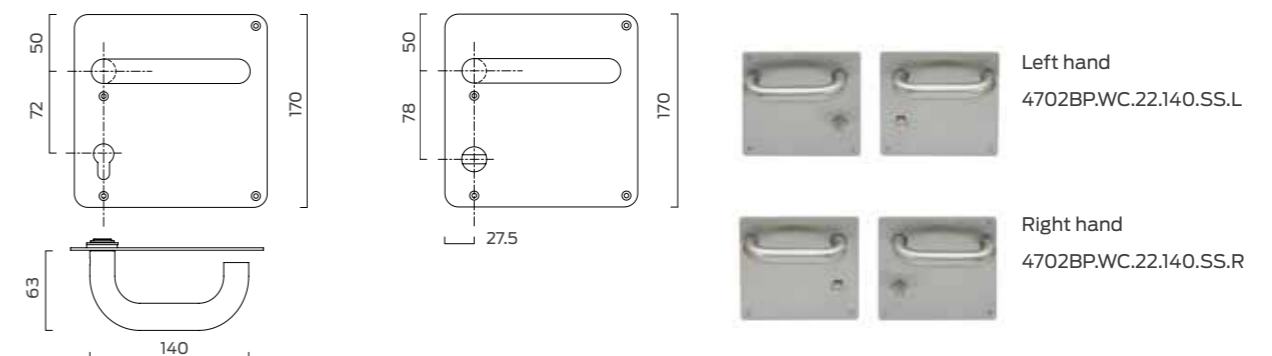

Product Ref:	4713.4	4714.4	4715.4
Function:	Euro profile cylinder escutcheon	Lever key escutcheon	Blank escutcheon
Description:	Ø52 x 4mm with snap on cover. Supplied as pairs as standard. Bolt through fixings supplied as standard suitable for doors 44mm-54mm. Alternative fixings available.		
Finish:	All items are available in Satin Stainless Steel		

Product Ref:	4710	4711
Function:	Bathroom turn & indicator	Bathroom extended turn & indicator
Description:	Ø52 x 4mm with 8mm spindle and bolt through fixings for doors 38 - 44mm For doors 44 - 54mm thick please specify 4710.XSP (for 4710) or 4711.XSP (for 4711)	
Finish:	All items are available in Satin Stainless Steel	

4700 Series - Pull Handles

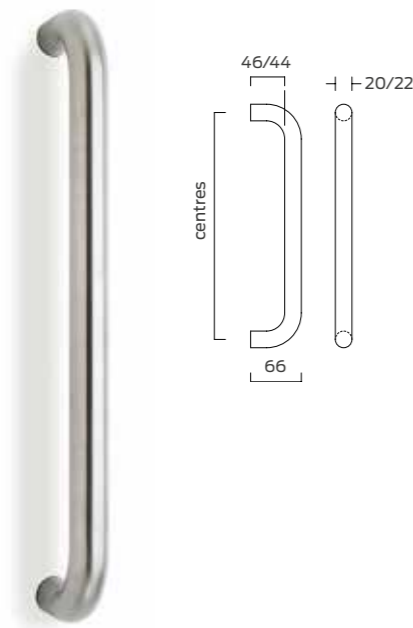

Description:	D pull handle - Round bar section							
Product Ref:	4721.20.200	4721.22.200	4721.20.300	4721.22.300	4721.20.400	4721.22.400	4721.20.600	4721.22.600
Diameter: mm	20	22	20	22	20	22	20	22
Centres:	200		300		400		600	

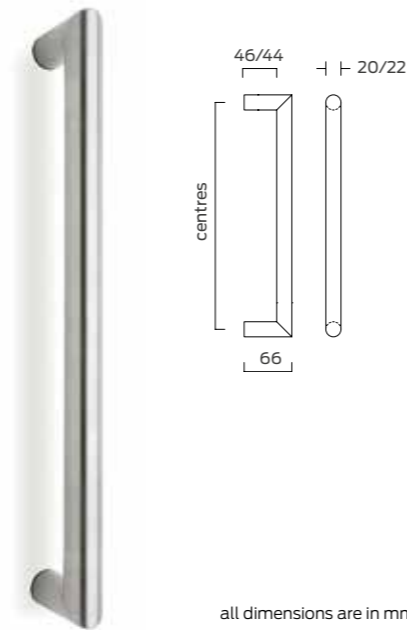

Description:	Mitred handle - Round bar section							
Product Ref:	4722.20.200	4722.22.200	4722.20.300	4722.22.300	4722.20.400	4722.22.400	4722.20.600	4722.22.600
Diameter: mm	20	22	20	22	20	22	20	22
Centres:	200		300		400		600	

all dimensions are in mm

Pull handles available as single or back to back

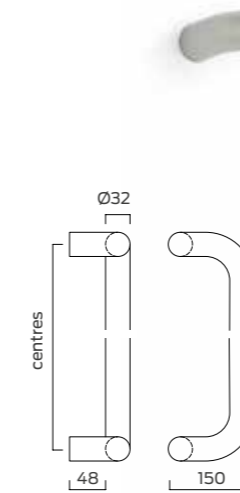

all dimensions are in mm

Description:	Cranked pull handle - Round bar section	
Product Ref:	4723.32.400	4723.32.600
Diameter:	32mm	32mm
Centres:	400	600

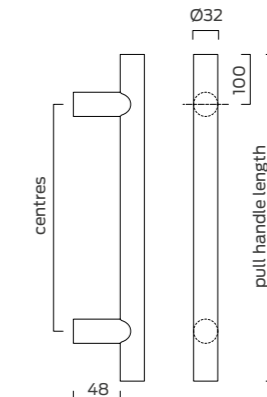

Description:	Pillar pull handle - Round bar section	
Product Ref:	4724.32.400	4724.32.600
Diameter:	32mm	32mm
Centres:	200	400



Pull handle fixings

All Briton 4700 Series pull handles can be ordered individually and must be ordered together with a standard fixing pack which contains all the components required to mount the pull handle in any of the 4 applications shown opposite.

For back to back assembly simply order two individual pull handles plus two standard fixing packs.

Product Ref:	Description
4726	Standard fixing pack for timber, metal or glass doors (order 2 packs for back to back assemblies)

Pull handle fixing options (included in Standard fixing pack)

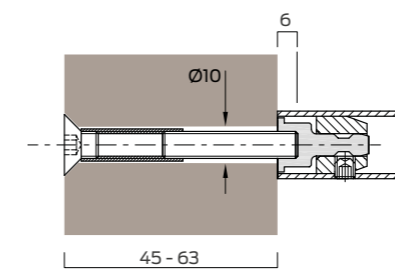

Bolt through - single pull handle

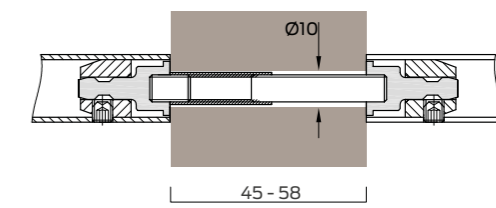

Back to back pair on timber door

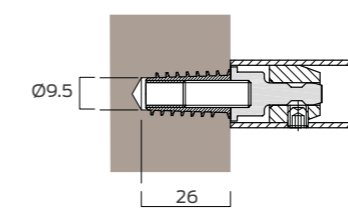

Secret fix - single pull handle

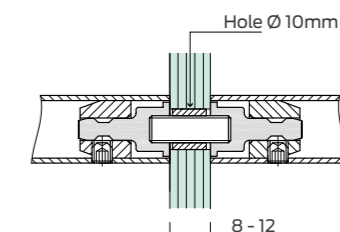

Back to back pair on glass door

4700 Series - Pull Handles & Push Plates

Rose mount fixings

Briton 4721 and 4722 pull handles can be ordered with an optional face fixed rose. Roses are supplied with stainless steel face fixing screws. Snap fit push on covers conceal all fixings.



Push plates

A range of push plates with radiused corners designed for use on the reverse of a pull handle with bolt through fixing. Each plate should be chosen to cover the pull handle fixing bolts.



4700 Series - Accessories

Symbols & signage

A range of 76mm dia. x 1.5mm face fixed stainless steel signs and symbols are available. Supplied with stainless steel woodscrew fixings.



Cylinder pull

Formed stainless steel cylinder pull for euro profile cylinder supplied with stainless steel face fixing screws. Ideally suited to use with mortice nightlatches.

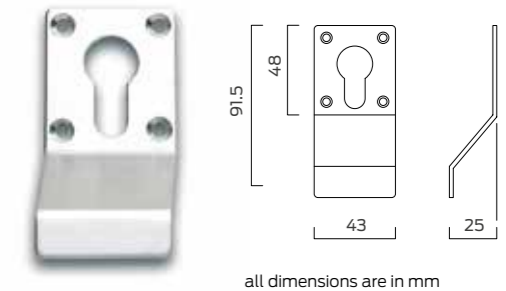

Product Ref:	Description
4733	Cylinder pull with aperture for euro profile cylinder.

Rose mount fixings

One fixing pack is required for each pull handle and they must be ordered according to the pull handle diameter (20 or 22mm).

Product Ref:	Description
4725.20	Face fixed rose mounting kit for 20mm diameter pull handles.
4725.22	Face fixed rose mounting kit for 22mm diameter pull handles.

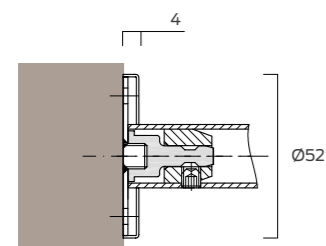

Product Ref:	Description
4730.75.375	75mm x 375mm Plain
4730.75.475	75mm x 475mm Plain
4730.75.675	75mm x 675mm Plain
4731.75.375	75mm x 375mm Engraved 'PUSH'
4731.75.475	75mm x 475mm Engraved 'PUSH'
4731.75.675	75mm x 675mm Engraved 'PUSH'
4732.75.375	75mm x 375mm Engraved 'PULL'
4732.75.475	75mm x 475mm Engraved 'PULL'
4732.75.675	75mm x 675mm Engraved 'PULL'

Product Ref:	Description
4750.01	Unisex symbol
4750.02	Male symbol
4750.03	Female symbol
4750.04	Disabled symbol
4750.05	WC sign
4750.06	Shower symbol
4750.07	Baby Change symbol
4750.08	Push
4750.09	Pull
4750.10	Fire door keep shut
4750.11	Fire door keep locked
4750.12	Automatic fire door keep clear



4700 Series - Accessories

Door stops

A series of wall and floor mounted door stops. Supplied with stainless steel fixings.



Ref:	4740	4741	4742	4743
Description:	Domed floor mounted door stop	Floor mounted door stop	Wedge shaped floor mounted door stop	Wall or skirting mounted door stop
Dimensions:	Ø45 x 24mm	Ø40 x 38mm	Ø46 x 26mm	Ø50 x 90mm

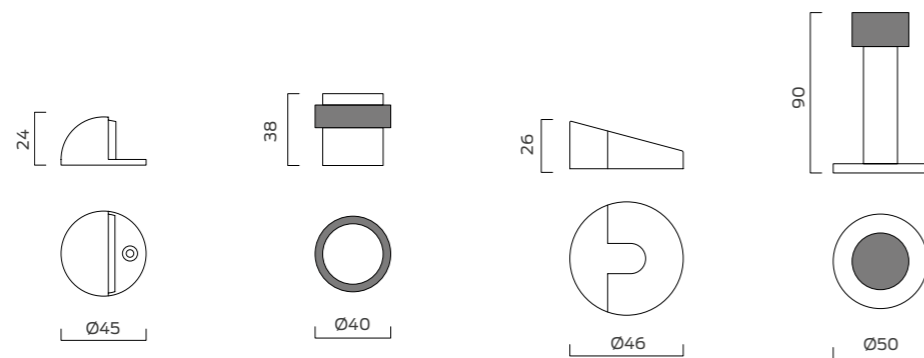

Kick plates

Kick plates are available in Grade 304 stainless steel in heights and widths to order. Plates have square corners as standard but are also available with radiused corners (5mmR or 10mmR).

Supplied with face fixings as standard (self adhesive option also available).

Other options and materials are available - please ask for details.

Plates are priced per square metre.



Ref:	Description
4760.304	Kick plate 1.2mm thick. Satin stainless steel Grade 304. Square corners with face fixing screws.
4761.304	Kick plate 1.5mm thick. Satin stainless steel Grade 304. Square corners with face fixing screws.

4700 Series - Accessories

Hooks

A series of face fixed single and double hooks. Supplied with stainless steel face fixings.

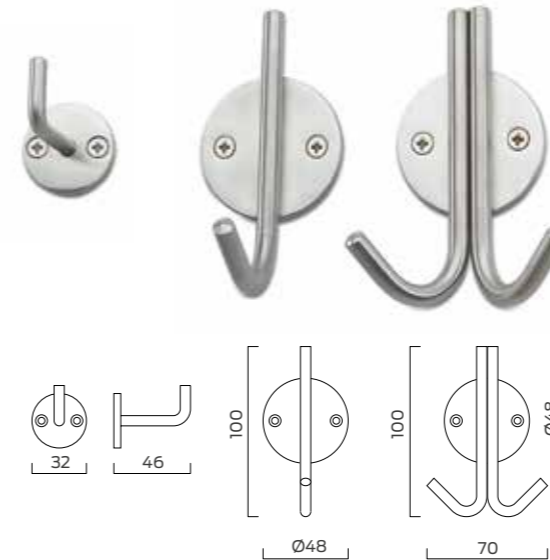

Ref:	Description
4744	Single hook - small, face fixed
4745.1	Single hook - large, face fixed
4745.2	Double hook - large, face fixed

4800 Series - Hinges

The first step in specifying hardware for any door is the method of hanging. Unless the door is to be fitted with a floor spring the door will be fitted with hinges, normally with 3 hinges per leaf (or more for larger or heavier doors, fitted in a pattern in accordance with BS EN 1935). The use of high quality hinges which are accurately fitted can have a significant bearing on the operating characteristics of the door which in turn will affect the efficiency of other hardware items, notably door closers and mortice locks.



High performance for all commercial applications

Features & Benefits

- Five knuckle ball bearing hinges.
- Suitable for timber and metal doors up to 120kgs.
- Template drilled for consistency and accuracy.
- Grade 304 stainless steel and in satin or polished finish.
- Also available with machine screws for use with metal doorsets.



Product ref.	Size	Material Grade	Finish
4801	102 x 76 x 3mm	304	SS; PS
4802	102 x 89 x 3mm	304	SS; PS
4803	102 x 102 x 3mm	304	SS; PS

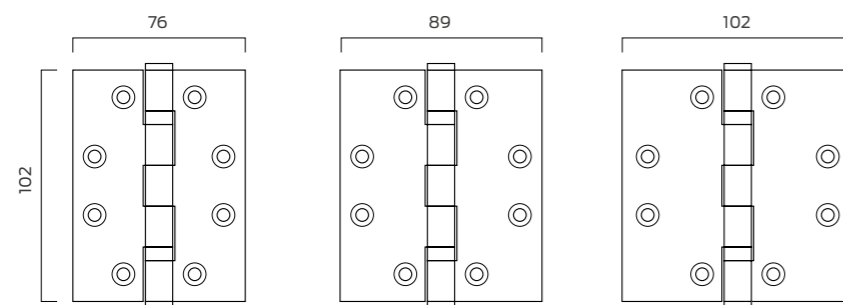

IMPORTANT NOTE - Fire door applications

A hinge which is certified for a 1 hour fire door can not be fitted to a 30 min fire door unless certified as the door constructions may be different.

Testing & Certification

CE marked to EN1935:2002 Grade 13

CE classification: **4 7 6 1 1 4 0 1 3**

Fire tested to EN1634 on timber doors to achieve a 30 minute and 1 hour fire rating

Full Declaration of Performance available from our website at:

www.britondops.co.uk



What's in the box?

- Hinge boxed individually
- Installation instructions

4200 Series - Contract Lever Furniture

The Briton Contract Series of door hardware is a compact range of lever furniture and accessories in the most popular designs. All items are available in satin stainless steel finish.



Features & Benefits

- All items manufactured in stainless steel Grade 304
- Levers are prefixed to sprung roses with push on covers in satin stainless steel
- M4 bolt through fixings and threaded bushes on lever furniture provide a strong bolt through fixing.
- Supplied with spindle and fixings as standard to suit doors 38 - 54mm thick
- Levers supplied with 8mm spindle
- Sprung roses 8mm thick with matching escutcheons

all dimensions are in mm

A compact range of contract quality door furniture in satin stainless steel



4201.19.SS

Return to door, Ø19mm round bar lever handle on rose with bolt through fixings at 38mm centres.

Conforms to dimensional recommendations of BS 8300.

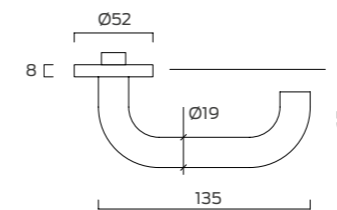

all dimensions are in mm



4203.19.SS

Straight Ø19mm round bar lever handle on rose with bolt through fixings at 38mm centres.

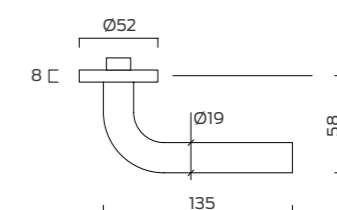

Testing & Certification

Tested to EN 1906 with Grade 3 Category of Use

Tested to EN 1906 with Grade 7 Durability (200,000 cycles)

Tested to EN 1673 with Grade 3 Corrosion Resistance

Fire tested to EN1634 on timber doors to achieve a 2 hour fire rating, and 4 hour for metal doors.

Full Declaration of Performance available from our website at:

www.britondops.co.uk



What's in the box?

- Pair of levers on roses
- Push on rose covers
- 8mm spindle & bolt through fixings for 35 - 54mm doors
- Hexagon wrench

4200 Series - Contract Lever Furniture



4204.19.SS

Straight mitred, Ø19mm round bar lever handle on rose with bolt through fixings at 38mm centres.



4205.19.SS

Curved mitred Ø19mm round bar lever handle on rose with bolt through fixings at 38mm centres.

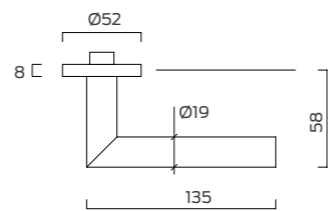
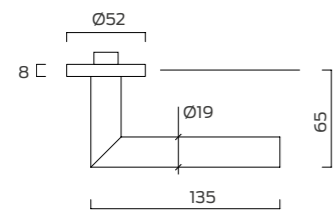

Ref:	4070
Description:	Domed floor mounted door stop for wood/concrete floors
Dimensions:	Ø40 x 24mm



Product Ref:	4213.8.SS	4214.8.SS	4215.8.SS
Function:	Euro profile cylinder escutcheon	Lever key escutcheon	Blank escutcheon
Description:	Ø52 x 8mm with snap on cover. Supplied as pairs as standard. Bolt through fixings supplied as standard suitable for doors 44mm-54mm. Alternative fixings available.		



Product Ref:	4210	4211
Function:	Bathroom turn & indicator	Bathroom extended turn & indicator
Description:	Ø52 x 8mm with 5mm spindle and bolt through fixings for doors 38 - 44mm	

Product ref.	Description	Material Grade	Finish
4201.19.SS	Rose mounted lever handles - Ø19mm round bar return to door	304	.SS
4203.19.SS	Rose mounted lever handles - Ø19mm round bar straight	304	.SS
4204.19.SS	Rose mounted lever handles - Ø19mm straight mitred	304	.SS
4205.19.SS	Rose mounted lever handles - Ø19mm curved mitred	304	.SS
4213.8.SS	Euro profile cylinder escutcheon - pair	304	.SS
4214.8.SS	Lever key escutcheon - pair	316	.SS
4215.8.SS	Blank escutcheon - pair	304	.SS
4210.SS	Bathroom turn and indicator	304	.SS
4211.SS	Extended bathroom turn and indicator	304	.SS
4200.5.FP	5mm x 60mm spindle and adapter for lockcases with 8mm bathroom function followers	316	.SS
4070	Domed floor mounted door stop	316	.SS

NORMBAU - Nylon Door Furniture

Normbau solid nylon hardware has a proven track record of durability and performance. Coloured throughout, it will not chip or fade making it the ideal choice for public and commercial areas of heavy usage such as schools, hospitals and leisure centres.



Lever assemblies

Levers are supplied in 3 arrangements with loose roses or backplates (as shown opposite) or pre-assembled with the rose or backplate inner.

In all cases, one lever is supplied with a floating spindle which engages within the lever on the opposite side.

All lever and rose or backplate assemblies are supplied with back to back through fixings to give a positive and durable assembly.

Tough, hygienic and warm to the touch

Features & Benefits

- Available in solid nylon or with a steel core for additional strength
- All products are available with an anti-microbial ingredient which provides high levels of resistance to the spread of bacterial infections
- Normbau nylon products are precision manufactured from high strength polyamide nylon that is:
 - Scratch resistant
 - Hygienic
 - Cadmium free
 - Anti-static
 - Highly resistant to weather, fading and ageing
- All lever assemblies have concealed bolt through fixings with snap on rose, escutcheon and backplate covers
- Supplied with all fixings and spindles for specified door thicknesses
- Resistant to conventional domestic cleaners, disinfectants, dilute acids and alkalis.
- Inherently warm to the touch making them ideally suited to situations which have to conform to BS 8300 recommendations
- All products are available as standard in 9 distinctive colours

Ball bearing mounting

Levers are supplied with backplates or roses which incorporate a ball bearing race which retains the lever for a quick and maintenance free assembly.

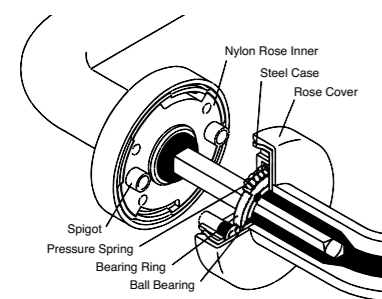

Fixed roses and backplates

Levers are supplied pre-assembled to the rose or plate inner with a friction washer and circlip fixing ensuring a durable performance.

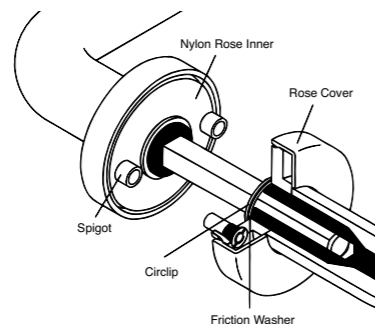

Spindle fixed separate levers

Levers are supplied with loose roses or backplates. The threaded end of the floating spindle is held firmly in place within the inside lever by a grub screw.

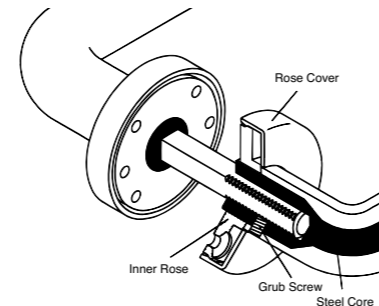

Testing & Certification

Tested to EN 1906 with Grade 4 Category of Use

Approved by PSA to MOB H3PS high duty performance

Fire tested to EN1634 on timber doors to achieve a 1 hour fire rating (pull handles), 2 hour rating (lever furniture) and 4 hour for metal doors (pull and lever furniture).

Full Declaration of Performance available from our website at:

www.britondops.co.uk



What's in the box?

- Pair of levers on roses
- Push on rose covers
- 8mm spindle & bolt through fixings for 35 - 54mm doors
- Hexagon wrench
- Installation instructions

NORMBAU - Nylon Door Furniture



Protection from harmful micro-organisms



Public areas are touched frequently and by many hands – so hygiene can often be a concern. NORMBAU® products contain an effective antibacterial protection which helps eliminate potentially harmful bacteria, in these frequently contacted products.



All products are available as standard in 9 distinctive colours. Other colours to match corporate environments can be achieved at additional cost.

For the purpose of colour co-ordination with other building elements we have provided the nearest RAL-DS colour reference.

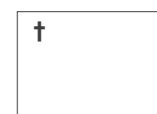

White 19 - NWH
RAL-DS 000 95 00

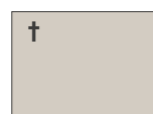

Manhattan 67 - NMG
RAL-DS 080 70 05



Dk Grey 18 - NDG
RAL-DS 000 35 00



Black 16 - NBL
RAL-DS 000 15 00



Slate Blue 63 - NSB
RAL-DS 240 50 15



Blue 11 - NBU
RAL-DS 270 30 40



Dk Blue 37 - NDB
RAL-DS 270 20 25



Red 12 - NRE
RAL-DS 030 30 45



Yellow 22 - NYE
RAL-DS 080 80 90

† Colours with antibacterial protection as standard



Normbau antibacterial protection is an integral constituent embedded within the nylon during production which provides effective and long-lasting protection against the growth of harmful micro-organisms and bacteria such as E.coli, S. aureus and MRSA.

It provides an extra level of hygiene in hospitals, care homes and many other types of public access buildings, helping to keep surfaces cleaner and reduce the risk of cross-contamination.

Please note, colours marked † opposite have the Normbau antibacterial protection as standard.

NORMBAU - Nylon Door Furniture

Ball bearing mounting

Levers and knobs are supplied for mounting on specific ball bearing roses or backplates.

For rose mounted versions please specify the rose and appropriate escutcheon required.

For plate mounted versions specify the plate function required.

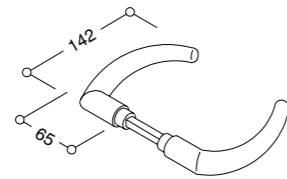

Ref:	23mm Ø - Coupe lever Steel cored
0282 01	Lever pair c/w spindle
0282 03	1/2 set without spindle

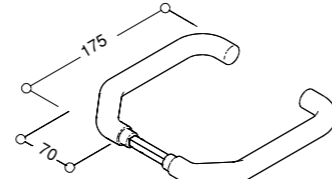

Ref:	23mm Ø - Cranked lever - Steel cored
0388 01	Lever pair c/w spindle
0388 03	1/2 set without spindle
0388 41	1/2 set c/w 1/2 spindle

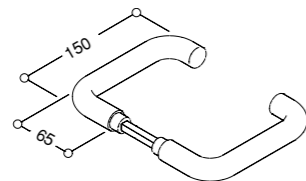

Ref:	23mm Ø - Return to door lever - Steel cored
0389 01	Lever pair c/w spindle
0389 03	1/2 set without spindle
0389 41	1/2 set c/w 1/2 spindle

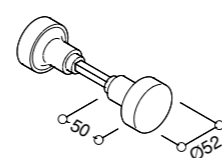

Ref:	52mm Ø - Knob
0387 01	Knob pair c/w spindle
0387 05	1/2 set without spindle

Fixed roses and backplates

Levers are supplied pre-fixed to the rose or plate inner. Cover plates are snap fit to conceal all fixings.

For rose mounted versions, specify the appropriate escutcheons if required.

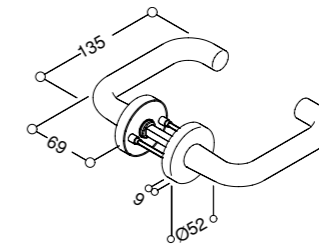

Ref:	20mm Ø - Steel cored lever on 52Ø rose
0516 01	Lever pair c/w spindle

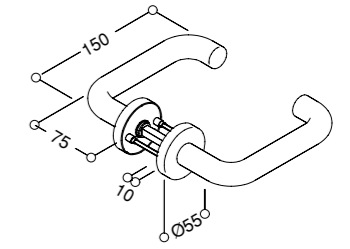

Ref:	23mm Ø - Steel cored lever on 55Ø rose
0516 03	Lever pair c/w spindle

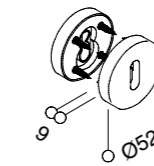

Ref:	Escutcheons 52mm Ø
0247 26	Blind escutcheon
0247 31	Lever key escutcheon
0247 32	Euro profile cylinder escutcheon
0247 90	Oval profile cylinder escutcheon
0358 34*	Bathroom turn/indicator
6432 00**	Bathroom turn - large, and indicator

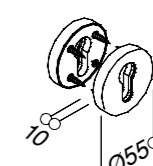
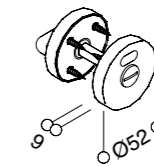

Ref:	Escutcheons 55mm Ø
0396 26	Blind escutcheon
0396 31	Lever key escutcheon
0396 32	Euro profile cylinder escutcheon
0396 47	Oval profile cylinder escutcheon
0397 40**	Bathroom turn/indicator

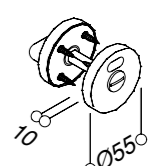

Roses, escutcheons and backplates

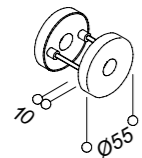

Ref:	Ball bearing rose
0390 03	Pair - suitable for all levers and knob

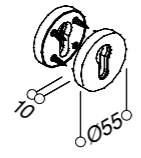

Ref:	Escutcheons
0396 26	Blind escutcheon
0396 29	Lever key escutcheon for lever locks
0396 30	Euro profile cylinder escutcheon
0397 40**	Bathroom function turn and indicator/release

** Supplied with 8mm spindle

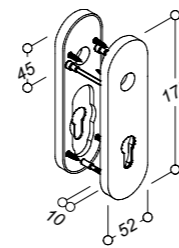
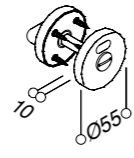

Ref:	Ball bearing plate
0405 05	Latch only
0405 02	Euro profile cylinder - 72mm c-c
0405 03**	Bathroom function - 78mm c-c

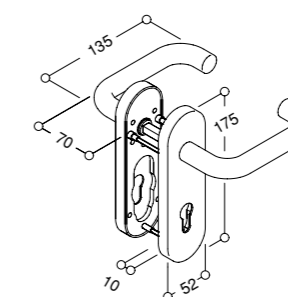

Plate mounted	20mmØ Lever	23mmØ Lever
Latch only	0623 20	0434 20
Lever key @ 57mm centres	0623 73	0434 73
Euro profile cylinder - 57mm centres	0623 74	0434 74
Euro profile cylinder - 72mm centres	0623 17	0434 17
Oval profile cylinder - 57mm centres	0623 75	0434 75
Oval profile cylinder - 72mm centres	0623 76	0434 76
Bathroom function - 57mm centres	0623 77*	0434 77*
Bathroom function - 78mm centres	0623 18**	0434 18**

* Supplied with 5mm spindle

** Supplied with 8mm spindle

NORMBAU - Nylon Door Furniture

Spindle fixed levers

Levers and roses or backplates are supplied separately.

Roses are available with springing to suit lightly sprung latches.

Levers are available in solid nylon or steel cored for extra strength and fire door applications. Steel cored levers must be ordered to suit the door thickness.

Remember to specify escutcheons if required when using rose mounted levers.

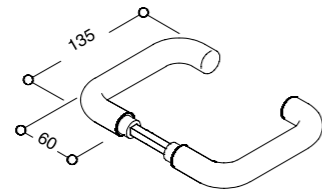

Ref:	20mm Ø lever
0246 08	Solid nylon
0570 15	Steel cored - for doors 23-37mm thick
0570 08	Steel cored - for doors 38-52mm thick
0570 14	Steel cored - for doors 53-63mm thick

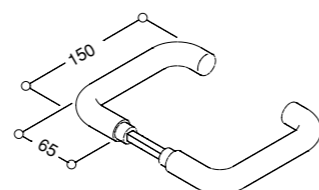

Ref:	23mm Ø lever
0246 18	Solid nylon
0571 15	Steel cored - for doors 23-37mm thick
0571 08	Steel cored - for doors 38-52mm thick
0571 14	Steel cored - for doors 53-63mm thick

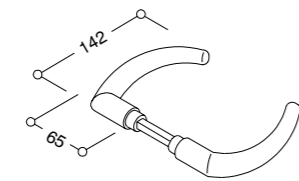

Ref:	23mm Ø Coupe lever
0577 01	Steel cored - for doors 23-37mm thick
0577 02	Steel cored - for doors 38-52mm thick
0577 03	Steel cored - for doors 53-63mm thick

The in-built strength of Normbau pull handles provides both durable fixing and lasting aesthetics. Available in either solid nylon or with a steel core for added strength, the pulls can be fitted singly or back to back in pairs using a variety of fixing types.

Each Normbau pull handle design is available as a 'thread side' or 'pin side' pull handle and should be specified according to the required fixing type. For example, a back to back pair requires one 'thread side' and one 'pin side' pull together with fixing pack 0471.

[Note: the smaller 23mm Ø pulls are the only exception and are supplied as dedicated single bolt through, back to back or face fixed assemblies].

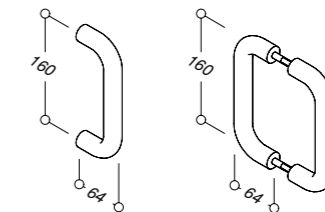

Ref:	23mm Ø solid nylon
0309 17	Single bolt through - supplied without fixings
0309 19	Back to back pair
0309 20	Single face fixing on 55mm Ø roses

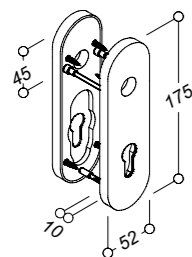

Ref:	Backplate mounting
0525 10	Latch only
0525 08	Lever key - 57mm c-c
0525 09	Euro cylinder - 57mm c-c
0523 22	Euro cylinder - 72mm c-c
0525 13	Oval cylinder - 48.5mm c-c
0525 14	Oval cylinder - 56mm c-c
0525 12	Oval cylinder - 57mm c-c
0525 11*	Bathroom function - 57mm c-c
0524 28**	Bathroom function - 78mm c-c

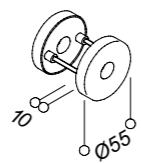

Ref:	Rose mounting
0247 10	Rose 52mm Ø
0247 39	Sprung inner to suit 52mm Ø rose
0396 02	Rose 55mm Ø

* Supplied with 5mm spindle
** Supplied with 8mm spindle

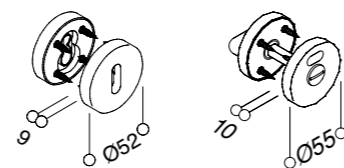

Ref:	Escutcheons 52 & 55mm Ø
0247 26	52mm Ø - Blind
0247 31	52mm Ø - Lever key
0247 32	52mm Ø - Euro cylinder
0247 90	52mm Ø - Oval cylinder
0358 34*	52mm Ø - Bathroom function
6432 00**	52mm Ø - Bathroom function - large turn
0396 26	55mm Ø - Blind
0396 29	55mm Ø - Lever key
0396 30	55mm Ø - Euro cylinder
0396 47	55mm Ø - Oval cylinder
0397 40**	55mm Ø - Bathroom function

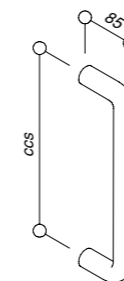

centres	34mm Ø steel cored	
	Thread side pull	Pin side pull
200mm	0439 01	0439 11
300mm	0444 01	0444 06
400mm	0363 19	0363 29
500mm	0363 18	0363 28
600mm	0363 17	0363 27

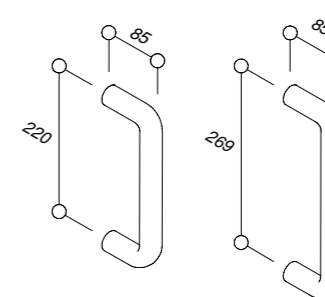

centres	34mm Ø solid nylon	
	Thread side pull	Pin side pull
220mm	0363 01	0363 11
269mm	0364 01	0364 11

NORMBAU - Nylon Door Furniture

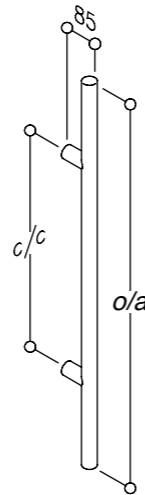
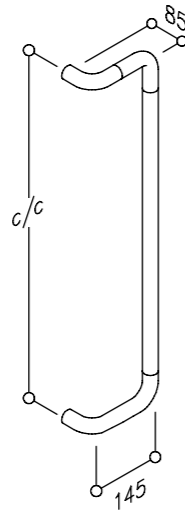
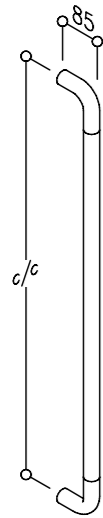

34mm Ø steel cored		
centres (mm)*	Thread side pull	Pin side pull
230 - 670	0767 01	0767 06
671 - 1170	0767 03	0767 08
1171 - 1660	0767 04	0767 09
1661 - 2200	0767 05	0767 10

34mm Ø steel cored		
centres (mm)*	Thread side pull	Pin side pull
201 - 670	0767 11	0767 16
671 - 1170	0767 13	0767 18
1171 - 1600	0767 14	0767 19
1601 - 2200	0767 15	0767 20

34mm Ø steel cored		
centres (mm)*	Thread side pull	Pin side pull
200 - 510	0767 21	0767 26
511 - 1010	0767 23	0767 28
1011 - 1460	0767 24	0767 29
1461 - 2200	0767 25	0767 30

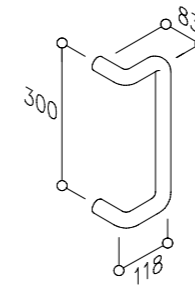

31mm Ø solid nylon		
centres	Thread side pull	Pin side pull
300mm	0443 12	0443 22

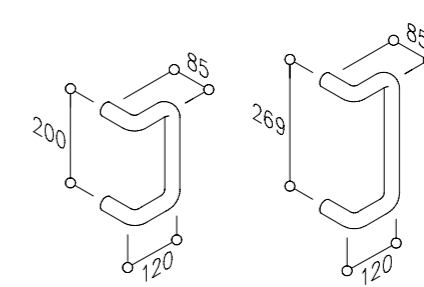

34mm Ø solid nylon		
centres	Thread side pull	Pin side pull
200mm	0438 02	0438 12
269mm	0303 06	0303 16
300mm	0443 02	0443 32

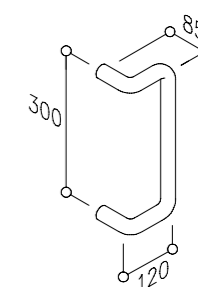
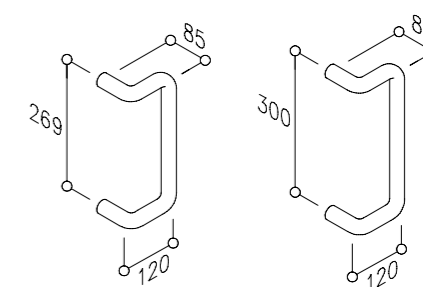

* The pull handles shown on this page are made to order to suit the fixing centres required. The figures shown in the tables above show the upper and lower limits of the centres.

For pillar fixed pull handles 0767 21 to 0767 30 the overall length of the handles is C/C + 200mm.

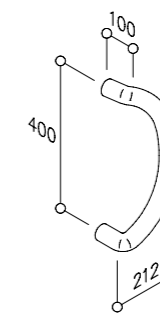

34mm Ø solid nylon		
centres	Thread side pull	Pin side pull
400mm	0440 10	0440 40

NORMBAU - Nylon Door Furniture

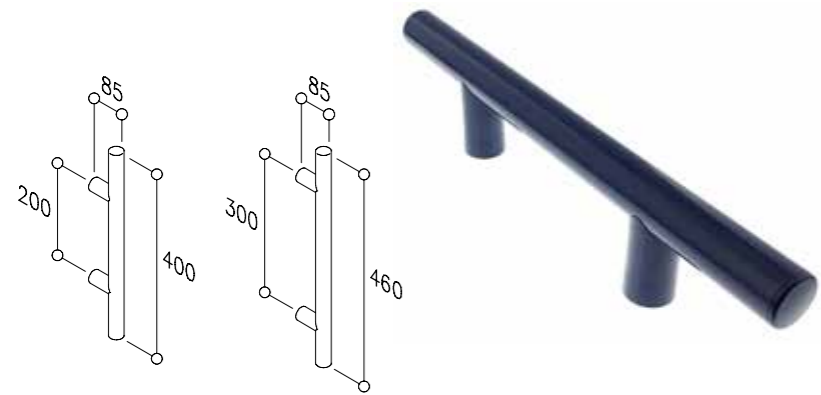

34mm Ø solid nylon		
centres	Thread side pull	Pin side pull
200mm	0441 01	0441 11
300mm	0445 01	0445 11

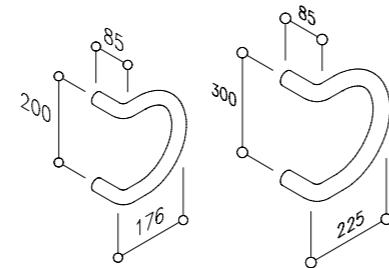

34mm Ø solid nylon		
centres	Thread side pull	Pin side pull
200mm	0440 01	0440 31
300mm	0440 06	0440 36

NORMBAU - Pull Handle Fixings

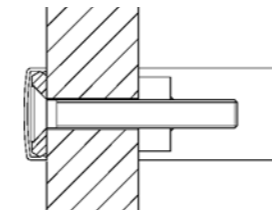

Product Ref:	Bolt through with screw cover cap
0365 12	For 31mm Ø pull handles
0365 12	For 34mm Ø pull handles
0365 22	For 40mm Ø pull handles
0365 37	Bolt only
	For use with 'thread side' pulls only

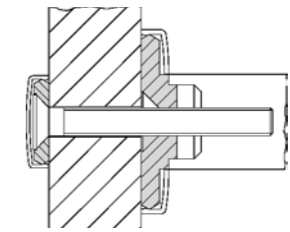

Product Ref:	Bolt through with screw cover cap & rose
0381 17	For 31mm Ø pull handles - roses 70mm Ø
0365 17	For 34mm Ø pull handles - roses 70mm Ø
0365 27	For 40mm Ø pull handles - roses 80mm Ø
	For use with 'thread side' pulls only

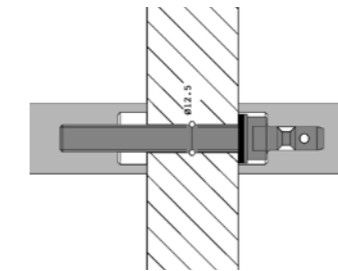

Ref:	Back to back fixing on timber
0471 11	For door thickness 38 - 48mm
0471 12	For door thickness 48 - 58mm
	Use with 'thread side' and 'pin side' pulls

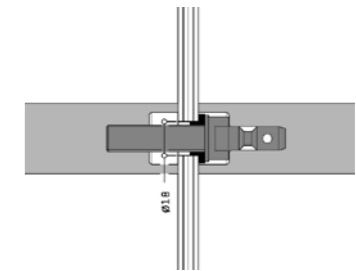

Ref:	Back to back fixing on glass
0471 44	For glass thickness 8 - 18mm
	Hole dia. in glass 12mm
	Use with 'thread side' and 'pin side' pulls

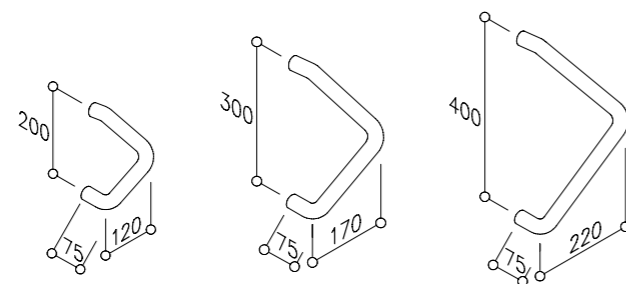

34mm Ø solid nylon		
centres	Thread side pull	Pin side pull
200mm	0440 09	0440 39
300mm	0440 11	0440 41
400mm	0440 13	0440 43

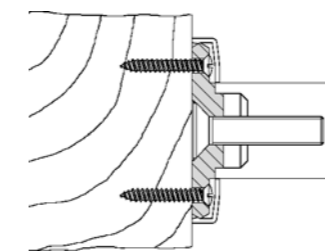

Ref:	Face fixing with covered roses
0381 19	For pull handles 31mm Ø - roses 70mm Ø
0365 19	For pull handles 34mm Ø - roses 70mm Ø
0365 29	For pull handles 40mm Ø - roses 80mm Ø
	For use with 'thread side' pulls only

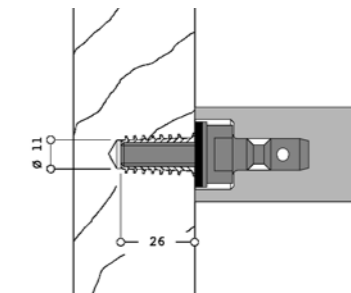

Ref:	Blind fixing on timber
0471 32	For all pull handles 31mm Ø - 40Ø
	For use with 'pin side' pulls only

NORMBAU - Accessories

Push plates for use with bolt through pull handles and kicking plates are available in a powder coated finish to match the Normbau Nylon colour range.

Push plates and kicking plates are supplied self adhesive. Screw fixed option available on request.

Please contact us for further information.



Ref: **7000 12**
Push plate
 Push plates available in various sizes

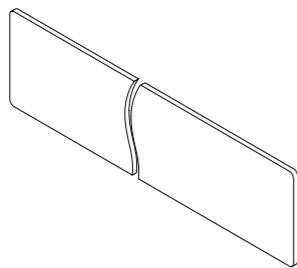

Ref: **7000 42**
Kicking plate
 Kicking plate available in size to order

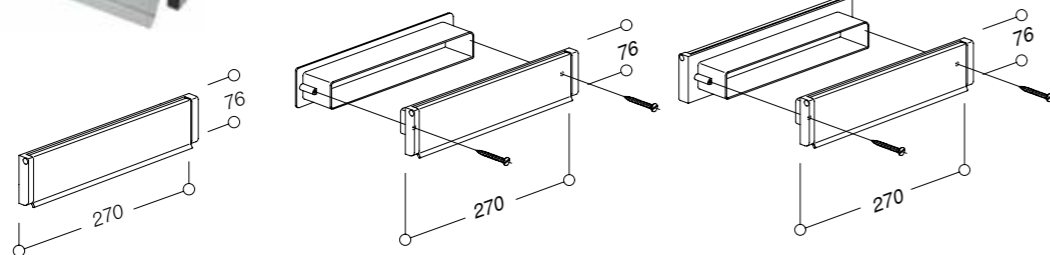

	Sprung letter plate only	Sprung letter plate & liner	Sprung letter plate, liner & inside tidy
Aperture size	230 x 35mm	254 x 45mm	254 x 45mm
Colours 16 & 19	0621 21	0621 23	0621 25
Other colours	0021 21	0021 23	0021 25

NORMBAU - Accessories

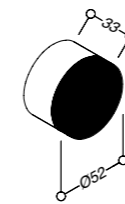

Ref: **0345 01**
Door stop
 Wall mounted with soft buffer



Ref: **0843 01**
Door stop
 Wall mounted with soft buffer

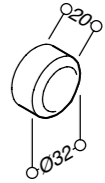

Ref: **0355 01**
Door stop
 Wall mounted

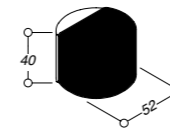

Ref: **0842 01**
Door stop
 Floor mounted with soft buffer

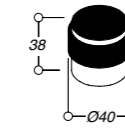

Ref: **0842 03**
Door stop
 Floor mounted with soft buffer

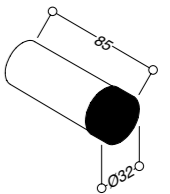

Ref: **0843 11**
Door stop
 Wall mounted with soft buffer

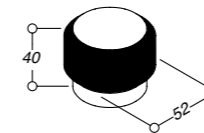

Ref: **0346 01**
Door stop
 Floor mounted with soft buffer



NORMBAU - Accessories

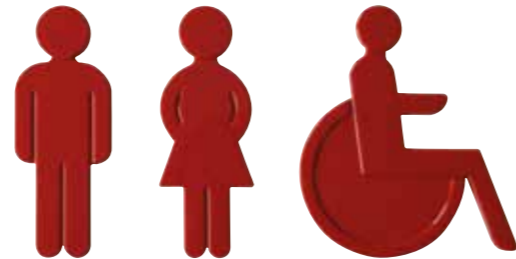

Product Ref:	Numerals - Self adhesive
0611 01	Figure 1 - 180mm high
0611 02	Figure 2 - 180mm high
0611 03	Figure 3 - 180mm high
0611 04	Figure 4 - 180mm high
0611 05	Figure 5 - 180mm high
0611 06	Figure 6 & 9 - 180mm high
0611 07	Figure 7 - 180mm high
0611 08	Figure 8 - 180mm high
0611 00	Figure 0 - 180mm high
0611 09	Letter a - 123mm high
0611 10	Letter b - 174mm high
0611 11	Letter c - 123mm high
0611 12	Letter d - 174mm high
0611 19	Dash (-) - 27mm high

Product Ref:	Symbols - Self adhesive
0510 01	Male - 130mm high
0510 02	Female - 130mm high
0510 04	Disabled - 130mm high

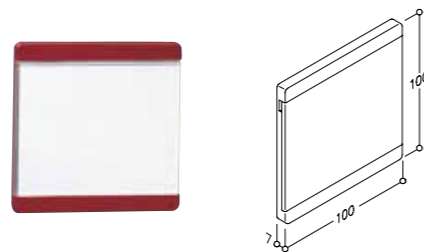

Product Ref:	Symbols - Self adhesive
0846 01	Male - 130mm high

NORMBAU - Accessories

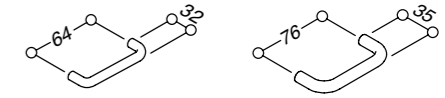

Product Ref:	Cabinet pulls - Bolt through fixing
0307 01	10mm Ø x 64mm - without screws
0307 02	10mm Ø x 64mm - with 4mm screws
0395 11	10mm Ø x 76mm - without screws

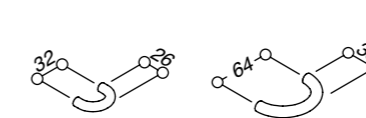

Product Ref:	Cabinet pulls - Bolt through fixing
0308 11	9mm Ø x 32mm - without screws
0308 01	11mm Ø x 64mm - without screws
0308 02	11mm Ø x 64mm - with 4mm screws

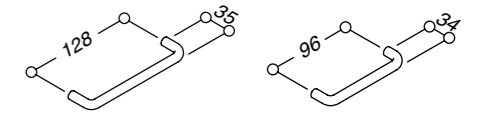

Product Ref:	Cabinet pulls - Bolt through fixing
0395 02	10mm Ø x 128mm - without screws
0395 05	10mm Ø x 128mm - with 4mm screws
0503 01	10mm Ø x 96mm - without screws

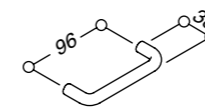

Product Ref:	Cabinet pulls - Bolt through fixing
0307 21	12mm Ø x 96mm - without screws
0307 22	12mm Ø x 96mm - with 4mm screws

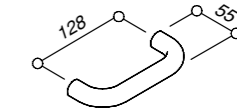

Product Ref:	Cabinet pulls - Bolt through fixing
0309 01	20mm Ø x 128mm - without screws
0309 09	20mm Ø x 128mm - with 4mm screws

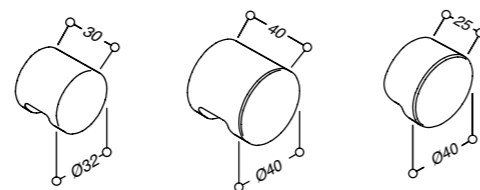

Product Ref:	Cabinet knobs - Bolt through fixing
0344 01	32mm Ø x 30mm projection
0391 01	40mm Ø x 40mm projection
0393 01	40mm Ø x 25mm projection
0234 02	52mm Ø x 52mm projection - pair
0234 04	52mm Ø x 52mm projection - single

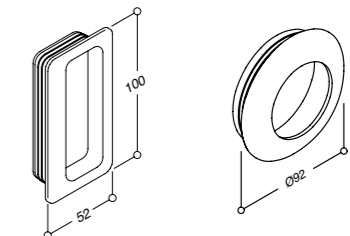
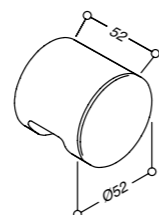

Product Ref:	Flush pulls
0342 01	Flush pull 100 x 52mm
0343 01	Flush pull 92mm Ø
0343 02	Flush pull 78mm Ø
0343 03	Flush pull 63mm Ø

NORMBAU - Accessories

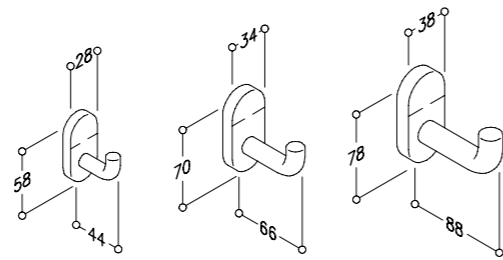

Product Ref:	Coat hook
0583 10	Coat hook - 44mm projection
0583 11	Coat hook - 66mm projection
0583 12	Coat hook - 88mm projection

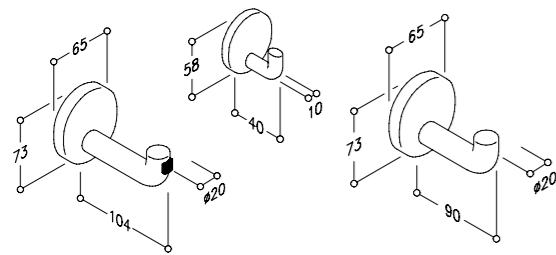

Product Ref:	Coat hook with buffer
0304 01	Coat hook with buffer - circular plate
0305 01	Coat hook - 10mm Ø
0339 01	Coat hook - 20mm Ø

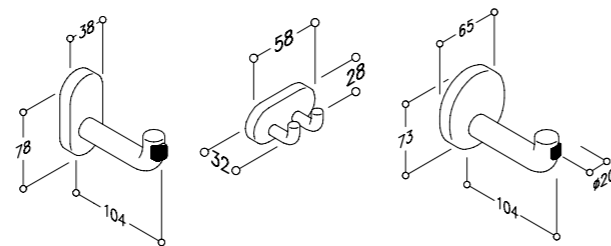

Product Ref:	Double coat hook
0583 15	Buffered coat hook on oblong plate
0583 20	Double coat hook - 10mm Ø
0340 01	Buffered coat hook on round plate

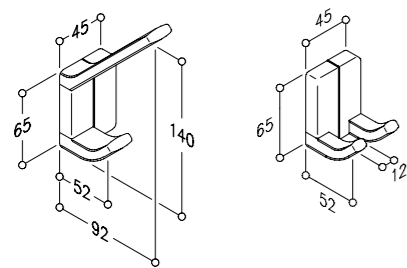

Product Ref:	Coat hook
0584 01	Hat & coat hook
0584 05	Double hook

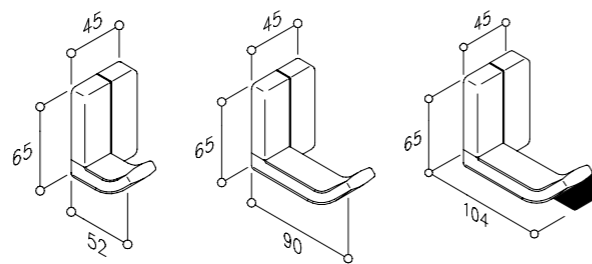

Product Ref:	Double coat hook
0584 02	Coat hook - 52mm projection
0584 03	Coat hook - 90mm projection
0584 04	Buffered coat hook - 104mm projection

NORMBAU - Accessories

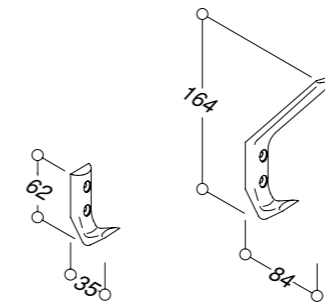

Product Ref:	Coat hook
0160 01	Coat hook 62 x 35mm
0160 02	Hat & coat hook 164 x 84mm

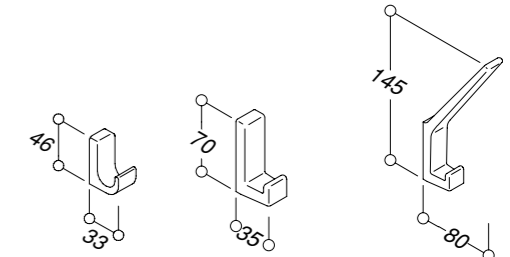

Product Ref:	Coat hook
0522 01	Coat hook 46 x 33mm
0180 04	Coat hook 70 x 35mm
0180 05	Hat & coat hook 145 x 80mm

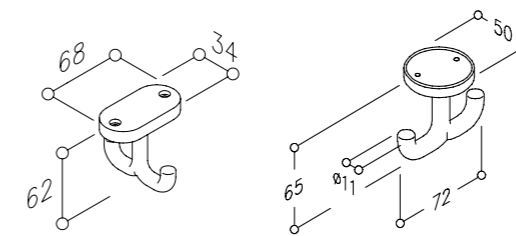

Product Ref:	Double coat hook
0583 25	Double ceiling hook - 11mm Ø x 68mm
0148 02	Double ceiling hook - 11mm Ø x 72mm

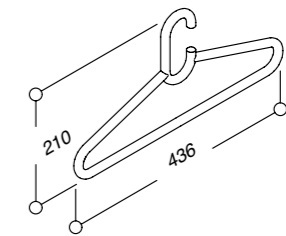

Product Ref:	Coat hangers
0338 01	Coat hanger - open
0512 01	Coat hanger - closed

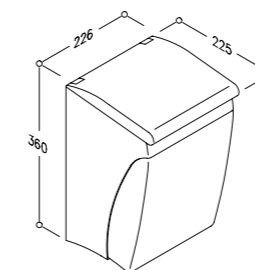

Product Ref:	Bin
0924 48	Waste bin

NORMBAU - Bathroom fittings

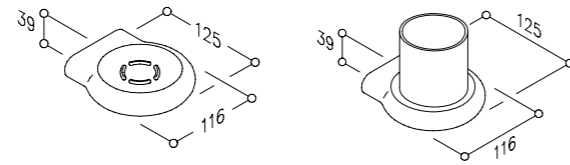

Product Ref:	Bathroom accessories
0925 01	Soap dish with drain hole
0925 02	Soap dish without drain hole
0925 11	Tumbler holder and nylon tumbler

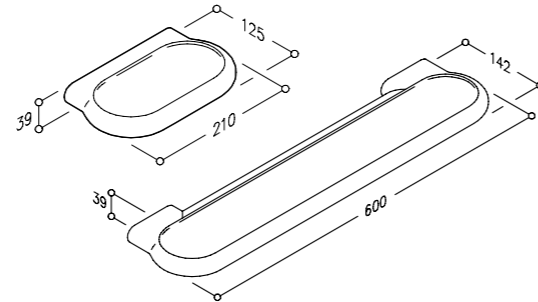

Product Ref:	Bathroom shelf
0925 21	Bathroom shelf - 125 x 210mm with drain hole
0925 22	Bathroom shelf - 125 x 210mm without drain hole
0925 26	Bathroom shelf - 143 x 600mm

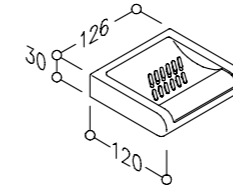

Product Ref:	Bathroom accessories
0824 01	Soap dish with drain hole
0824 02	Soap dish without drain hole

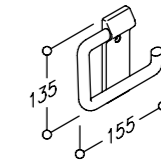

Product Ref:	WC roll holder
0149 01	Toilet roll holder

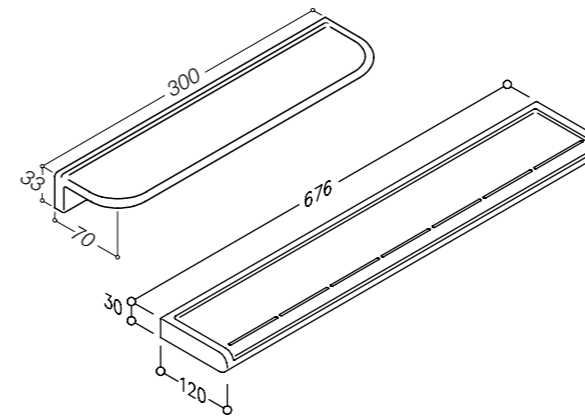

Product Ref:	Bathroom shelf
0146 01	Bathroom shelf 70 x 300mm
0826 01	Bathroom shelf 120 x 676mm

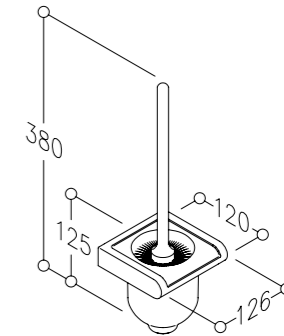

Product Ref:	Toilet brush set
0824 05	Toilet brush and wall mounted holder
0824 06	Replacement brush

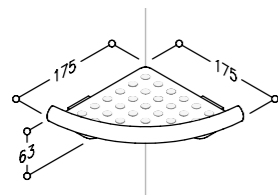

Product Ref:	Bathroom shelf
0925 33	Corner shelf

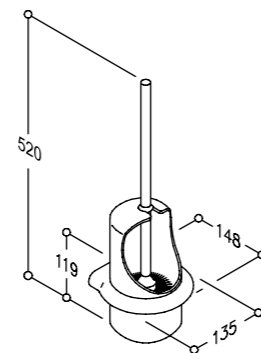

Product Ref:	Toilet brush set - anti theft
0925 40	Toilet brush and wall mounted holder
0925 45	Replacement brush

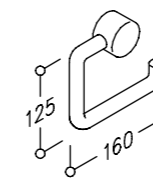

Product Ref:	WC roll holder
0399 01	Toilet roll holder
0399 02	Toilet roll holder with anti-theft device
0358 01	Key for 0399 02 anti-theft device

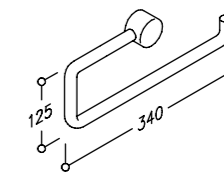

Product Ref:	Towel/roll holder
0583 02	Towel/tissue roll holder

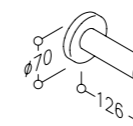

Product Ref:	WC roll holder
0518 01	Spare toilet roll holder

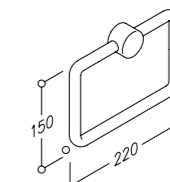

Product Ref:	Towel holder
0506 01	Towel holder

NORMBAU - Bathroom fittings

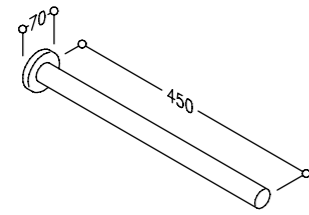

Product Ref:	Towel rail
0436 01	Towel rail - 450mm length - smooth rail
0436 05	Towel rail - 450mm length - tetured rail

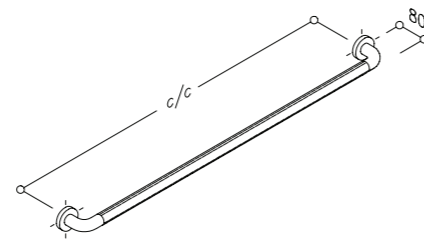

Product Ref:	Textured grab rails - Sectioned
0453 01	Grab rail - 1100mm centres
0453 02	Grab rail - 1000mm centres
0453 03	Grab rail - 800mm centres

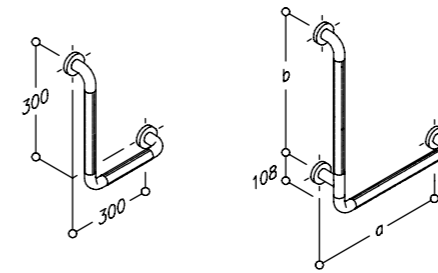

Product Ref:	Textured grab rails
0464 01	Grab rail - 300 x 620mm
0464 02	Grab rail - 300 x 300mm
0464 03	Grab rail - 400 x 750mm centres (a/b)
0464 04	Grab rail - 500 x 620mm centres (a/b)
0464 05	Grab rail - 500 x 750mm centres (a/b)

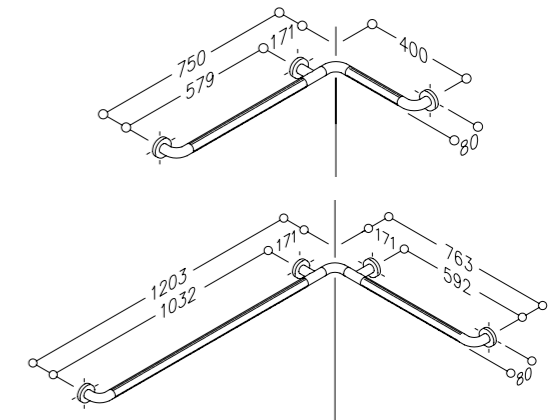

Product Ref:	Textured grab rails
0483 01	Corner rail - 763 x 763mm
0483 03	Corner rail - 400 x 750mm
0484 02	Corner rail - 763 x 1203mm

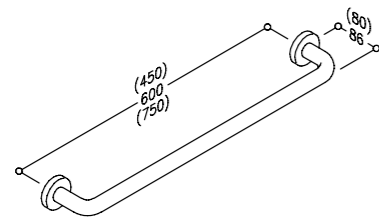

Product Ref:	Towel rail
0528 01	Towel rail - 450mm length - without roses
0528 02	Towel rail - 600mm length - without roses
0528 03	Towel rail - 750mm length - without roses
0528 11	Towel rail - 450mm length - with roses
0528 12	Towel rail - 600mm length - with roses
0528 13	Towel rail - 750mm length - with roses

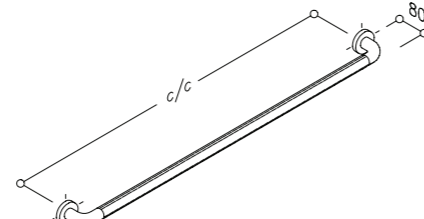

Product Ref:	Textured grab rails - Single piece moulding
0453 07	Grab rail - 600mm centres
0453 08	Grab rail - 400mm centres
0453 09	Grab rail - 300mm centres
0453 10	Grab rail - 500mm centres

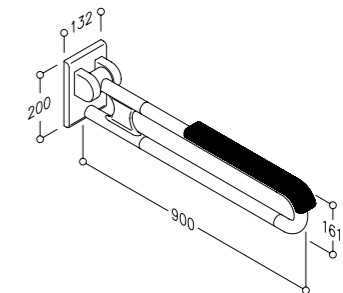

Product Ref:	Lift up support rail - padded armrest
0447 41	Lift up rail - 600mm (L)
0447 43	Lift up rail - 720mm (L)
0447 45	Lift up rail - 850mm (L)
0447 47	Lift up rail - 900mm (L)

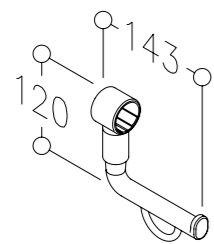

Product Ref:	Towel rail
0449 12	Toilet roll holder - 143 x 120mm

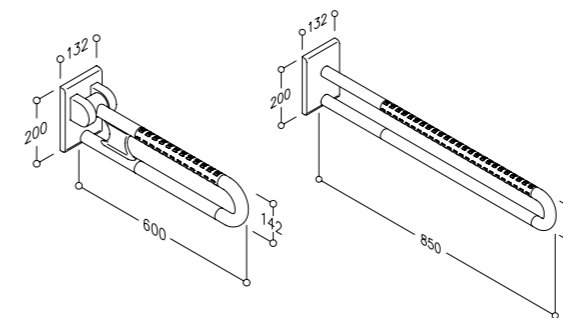

Product Ref:	Support rail - textured
0447 01	Lift up rail - 600mm (L)
0447 03	Lift up rail - 720mm (L)
0447 05	Lift up rail - 850mm (L)
0447 07	Lift up rail - 900mm (L)
0467 01	Fixed support rail - 600mm
0467 03	Fixed support rail - 725mm
0467 05	Fixed support rail - 850mm

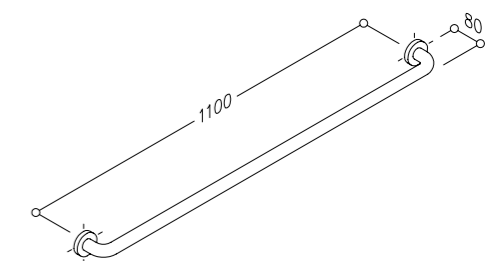

Product Ref:	Grab rail - steel cored
2053 03	Grab rail - 300mm centres
2053 04	Grab rail - 400mm centres
2053 05	Grab rail - 500mm centres
2053 06	Grab rail - 600mm centres
2053 08	Grab rail - 800mm centres
2053 10	Grab rail - 1000mm centres
2053 11	Grab rail - 1100mm centres

NORMBAU - Bathroom fittings

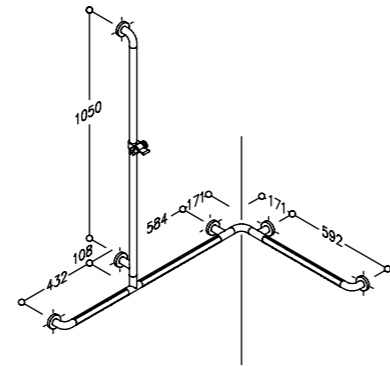

Product Ref: Shower head rail
0487 04 Corner shower head rail - reversible
0487 21 Corner shower head rail - 763 X 763 X 1158mm

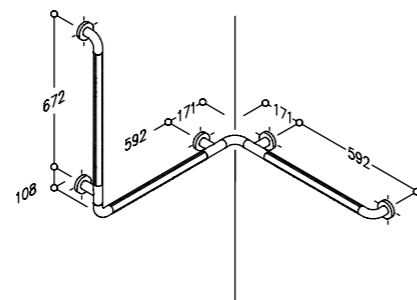

Product Ref: Shower hand rail
0485 01 Corner shower hand rail

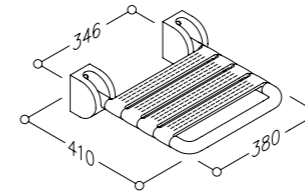

Product Ref: Shower seat - wall mounted
0841 01 Lift up shower seat - wall mounted

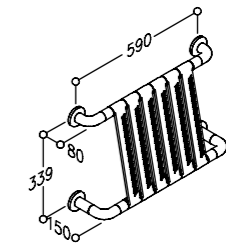

Product Ref: Backrest
0841 32 Wall mounted backrest

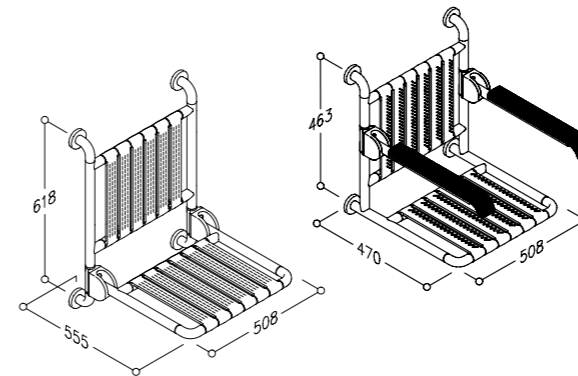

Product Ref: Shower seat - wall mounted
0841 11 Lift up seat with backrest
0841 24 Fixed seat with lift up padded armrests

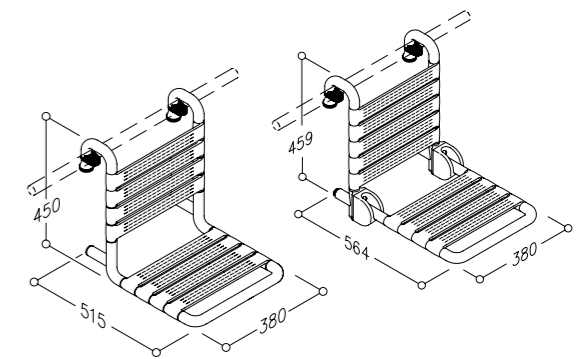

Product Ref: Shower seat - rail mounted/suspended
0847 01 Seat & backrest - 380 x 510 x 453mm
0847 11 Lift up seat & backrest - 380 x 564 x 459mm

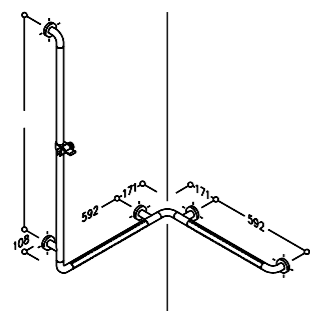

Product Ref: Shower head rail
0486 03 Corner shower head rail - 860mm high
0486 04 Corner shower head rail - 1158mm high
0486 051 Corner shower head rail - 750mm high
0486 052 Corner shower head rail - 1100mm high

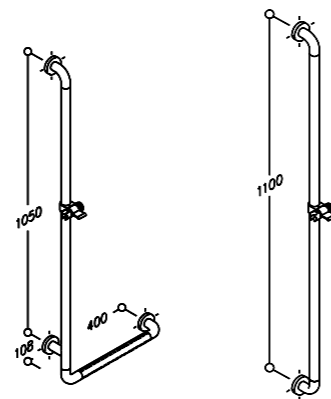

Product Ref: Shower head rail
0465 04 Shower head rail - 400 x 1158mm
0465 05 Shower head rail - 500 x 1158mm
0465 051 Shower head rail - 500 x 750mm
0465 052 Shower head rail - 500 x 1000mm
0488 03 Straight shower head rail - 1100mm centres
0488 05 Straight shower head rail - 1000mm centres
0488 07 Straight shower head rail - 800mm centres
0488 09 Straight shower head rail - 600mm centres

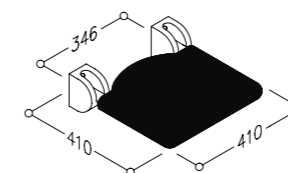

Product Ref: Shower seat - padded
0844 011 Lift up wall mounted shower seat - Grey
0844 010 Lift up wall mounted shower seat - Black

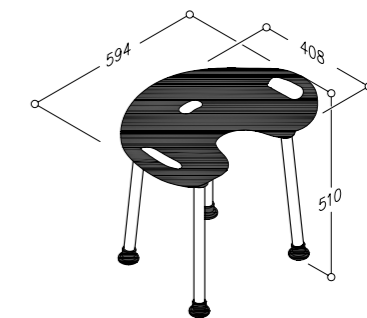

Product Ref: Stool
0300 345 Freestanding shower stool - padded seat - black
0300 346 Freestanding shower stool - padded seat - grey

Sliding & Folding Door Hardware - Where ideas unfold

Brio designs and manufactures a range of sliding and folding door hardware which is ideally suited to residential applications. The sliding and folding door gear is suitable for use with a variety of door or panel constructions and materials offering a variety of solutions for full height room doors, wardrobes, cupboards and cabinets.

	Capacity Kg	Top Hung Straight Sliding	Top Hung Folding	Bottom Rolling Straight Sliding	Face Fix Top level with ceiling	Soffit Fix Top level with ceiling	Multiple Line Option	Cabinet Glass
Multifold 30	30kg		■					
Wardrobe Double 50	50kg	■						
Single Run 60	60kg	■			*	■	■	
Single Run 80	80kg	■			*	■	■	
Single Run 120	120kg	■			*	■	■	
Glassroll 30	30kg			■				■

* Optional Extra

Multifold 30 - Interior folding door hardware

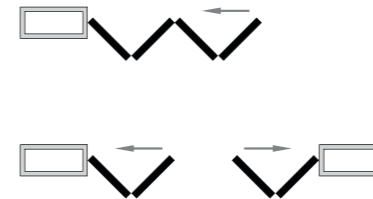

Application

Multifold 30 is an interior folding door hardware system. The axis on the pivot and hangers are within 25mm of the edge of the door, minimising the overhang of the panels, improving appearance and making it possible to fit trim to hide the gap between track and panel.

Features & Benefits

- Bearing hanger has a quick attach and release mechanism
- Height adjustment with single spanner makes installation and alignment easy
- Multiple configurations for 2 or 4 panel
- Aluminium slide track in head
- Non mortice hinges zinc plated
- Hangers have 4 nylon tyred ball bearing race wheels giving a smooth and quiet action
- Track available in lengths of: 2m, 3m, 4m and 6m

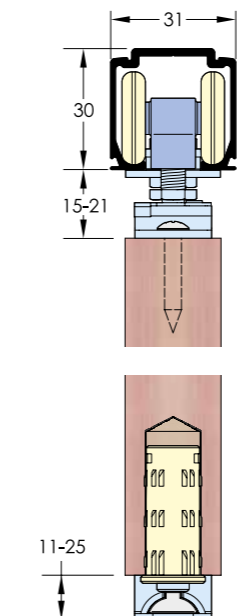

Application	MF30
Max. panel weight	30Kg
Max. panel width	650mm
Max. panel height	2400mm
Min. panel thickness	19mm
Adjustments:	±3mm in height ±4mm in horizontal

Product Ref:	Description
MF30-13/2	Multifold 30 kit for 2 panels
MF30-26/4	Multifold 30 kit for 4 panels

Single Run – Sliding door hardware

The Single Run series of top hung sliding door gear is available in 3 variations to suit doors up to 120kg. All variations are designed for use with a single door or panel. The sliding track can be mounted in a variety of positions within the structural opening allowing doors to slide across a wall or inside a pocketed wall cavity. The door gear can be used individually for a single door or in multiple lines where more than one door is needed.

Applications

Single Run 60 is primarily suited to residential applications on single doors

Single Run 80 and Single Run 120 bridge residential to light commercial applications designed for doors at 80Kg or 120Kg. Such doors are likely to be custom made and out of the ordinary.

All Single Run options can be applied to the wall structure in a variety of ways.

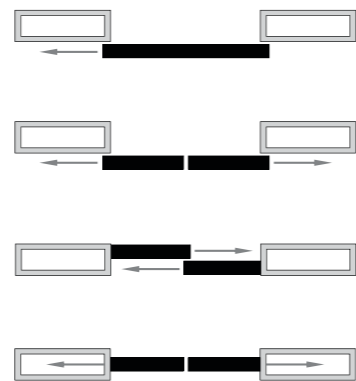

SR60 Principal Features

- Full 'C' section aluminium track
- 4 Wheels per hanger for long life, stability and high capacity
- Quick snap connection with side feed
- Simple height adjustment with single spanner
- Supplied with clip stops or 2 soft close devices

SR80 Principal Features

- Compact structural aluminium track soffit fixed as standard or face fixed if brackets used
- Track profile ensures wheels cannot disengage
- Glass reinforced nylon hanger body with steel plate ensures long life performance
- Precision bearings
- Supplied with clip stops as standard
- Soft close device upgrade available

SR120 Principal Features

- Chrome high speed precision bearings
- Cast stainless steel hangers
- Brush seals may be incorporated in the top track
- A range of bottom channels and guides is available

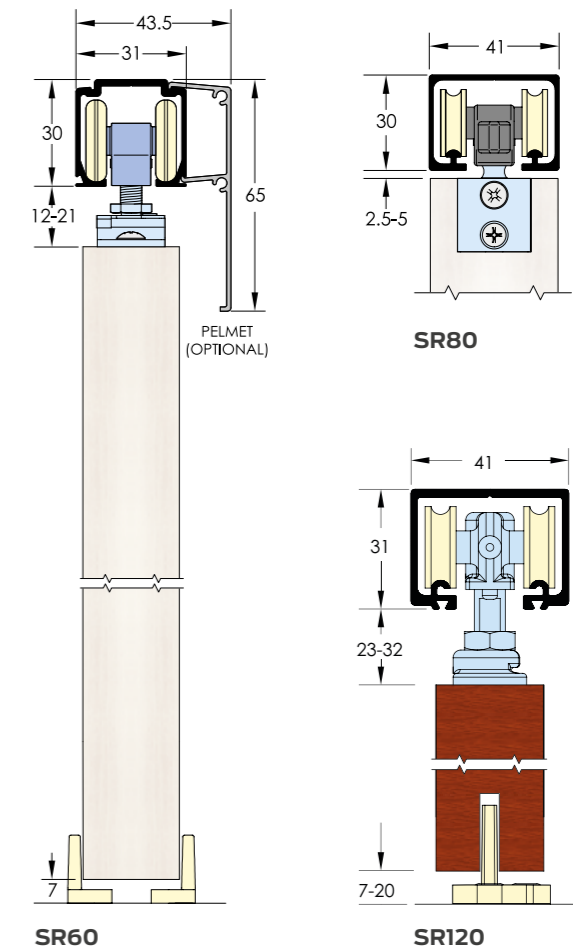

Application	SR60	SR80	SR120
Max. panel weight	60Kg	80kg	120kg
Max. panel width	1525mm	2000mm	2000mm
Max. panel height	2400mm	3000m	3000m
Min. panel thickness	19mm	28mm	28mm
Adjustments:	±4.5mm in height	±5.0mm in height	±4.5mm in height

Product Ref:	Description
SR60-20/1*	Single Run 60 kit for 1 panel - 2m track
SR60-30/1	Single Run 60 kit for 1 panel - 3m track
SR80-20/1	Single Run 80 kit for 1 panel - 2m track
SR80-30/1	Single Run 80 kit for 1 panel - 3m track
SR120-20/1	Single Run 120 kit for 1 panel - 2m track
SR120-30/1	Single Run 120 kit for 1 panel - 3m track

* Max panel width 915mm

Wardrobe Double 50 - Sliding door hardware

Wardrobe Double 50, as the name implies, is designed specifically for wardrobes. It is a top hung system that can accommodate panels weighing up to 50Kg each. The face fix hangers are adjustable and fitted on the blind side of the opening. The expectation of wardrobes is they operate in silence. Brio is one of a few manufacturers that use precision bearings as standard to reduce noise and ensures the system remains that way.



Application	WD50
Max. panel weight	50Kg
Max. panel width	900mm
Max. panel height	2400mm
Min. panel thickness	16mm
Adjustments:	±5mm in height

Product Ref:	Description
WD50-12/2	Wardrobe Double 50 kit - 2 panel - 1200mm track
WD50-15/2	Wardrobe Double 50 kit - 2 panel - 1500mm track
WD50-18/2	Wardrobe Double 50 kit - 2 panel - 1800mm track
WD50-24/3	Wardrobe Double 50 kit - 3 panel - 2400mm track

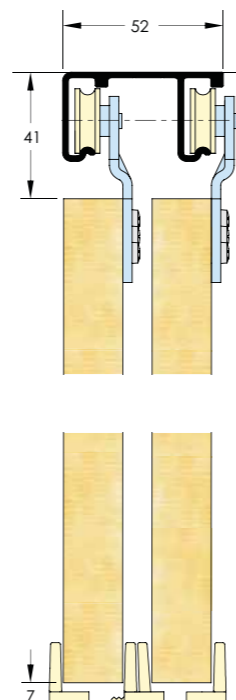

Glassroll 30 - Sliding glass system

Glassroll 30 is ideal for cabinets and display units. Glassroll 30 is one of the easiest cabinet systems to install and adjust. Unlike many others there is no need to remove and replace the panel numerous times to find the optimum height. Adjustment is possible with the glass panels in place, making installation accurate, quick and easy. For security, Glassroll comes with its own dedicated lock as an optional extra, which fits to the glazing rail.



Application	GR30
Max. panel weight	30Kg
Max. panel area	2.5m ²
Max. panel height	-
Min. panel thickness	6mm
Adjustments:	±1.5mm in height

Product Ref:	Description
GR30-12/2	Glassroll 30 kit - 2 panel - 1200mm track
GR30-15/2	Glassroll 30 kit - 2 panel - 1500mm track
GR30-18/2	Glassroll 30 kit - 2 panel - 1800mm track

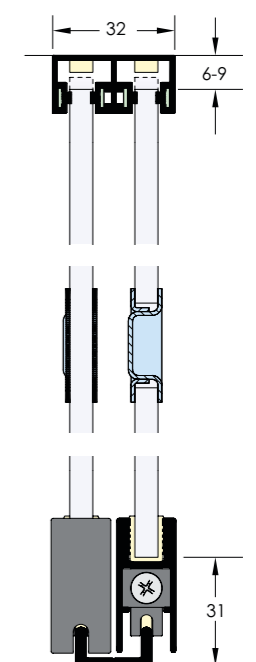

Cl/Sfb	(31.59)	X	
Uniclass	L4181		

June 2020

About Allegion

Allegion (NYSE: ALLE) is a global pioneer in seamless access, with leading brands like CISA®, Interflex®, LCN®, Schlage®, SimonsVoss® and Von Duprin®. Focusing on security around the door and adjacent areas, Allegion secures people and assets with a range of solutions for homes, businesses, schools and institutions. Allegion had \$2.7 billion in revenue in 2018, and sells products in almost 130 countries.

For more, visit allegion.com

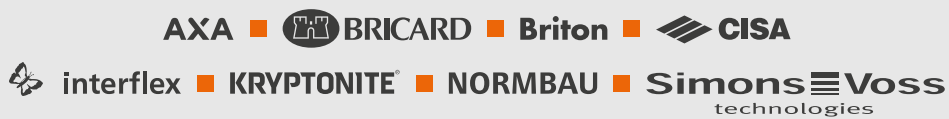

Allegion (UK) Limited

35 Rocky Lane
Aston
Birmingham
B6 5RQ

Tel: +44 (0) 121 380 2400
Email: contactuk@allegion.com
Web: allegion.co.uk